

WAHL®

**RECHARGEABLE SHAVER
INSTRUCTIONS**

SHAVER

Please read all instructions carefully to familiarise yourself with your new Wahl shaver before using.

Save these instructions for further reference.

For any further assistance or information call Customer Services on

T: 01227 740066

or visit

W: www.wahl.co.uk

E: customer.services@wahl.co.uk

CONTENTS

GENERAL USER INFORMATION	Page 3
IMPORTANT SAFEGUARDS	Page 4
DESCRIPTION OF PARTS	Page 9
OPERATING INSTRUCTIONS	Page 10
CLEANING AND MAINTENANCE	Page 14
TROUBLESHOOTING	Page 18
LITHIUM-ION BATTERY REPLACEMENT REMOVAL AND DISPOSAL	Page 19
WIRING	Page 20
DISPOSAL	Page 20
GUARANTEE	Page 21

GENERAL USER INFORMATION

Information about using the operation manual

- ▶ Before using the appliance for the first time, you must read and understand the operation manual completely.
- ▶ Consider the operation manual as part of the product and store it in a safe and accessible place.
- ▶ Include this operation manual if passing the appliance on to a third party.
- ▶ In the case of conflicts with national safety specifications or instructions, the national requirements must be followed.

Explanation of symbols and notes



DANGER

Danger of electric shock which may result in serious physical injury or death.



DANGER

Danger of explosion which may result in serious physical injury or death.



WARNING

Warning of possible physical injury or a health risk.



CAUTION

Information about danger of material damage.



Note with useful information and tips.

- ▶ Action to be taken by owner.
1. Carry out these actions in the sequence described.
- List

SHAVER

Please retain this leaflet for future reference.

READ ALL INSTRUCTIONS BEFORE USING.

IMPORTANT SAFEGUARDS

When using this electrical appliance, especially when children are present, basic safety precautions should always be observed including the following.

Requirements

- ▶ Read the instruction manual in full to familiarise yourself with the product before the first use.
- ▶ This appliance can be used by children from aged 14 years and above and persons with reduced physical, sensory or mental capabilities, or lack of experience and knowledge, if they have been given supervision or instruction concerning use of the appliance in a safe way and understand the hazards involved. Children shall not play with the appliance. Cleaning and user maintenance shall not be made by children without supervision.
- ▶ Use this appliance only for its intended purpose.
- ▶ This shaver is intended exclusively for trimming human hair. The shaver is designed for private home use and must not be used for commercial purposes.
- ▶ The shaver must only be used indoors.

- ▶ Do not use the device to cut artificial hair or animal hair
- ▶ Children must not play with packaging material. Do not allow children to play with plastic bags. Danger of suffocation.
- ▶ The hand-held shaver can be rinsed under running water.



DANGER! Disconnect the charger from the shaver first.

Hazards



Danger! Electric shock due to damage to appliance

- ▶ Do not operate the shaver if the shaver, the charger or the cable shows visible signs of damage or if the shaver has been dropped.
- ▶ Connect the cable to the shaver before plugging the charger into a power point.
- ▶ Only connect the charger to a properly installed easy to access power point supplying voltage matching the rating plate. The power point must still be easily accessible after connection.
- ▶ Ensure that the cable cannot be damaged by sharp edges or hot surfaces.
- ▶ Ensure that the cable is not trapped or crushed.
- ▶ Always pull at the charger and never pull on

SHAVER

the cable when unplugging the charger.

- ▶ Remove the charger from the power point:
 1. After each use
 2. After each charging process
 3. If a fault occurs
 4. Before connecting the device to the cable
 5. Before cleaning the shaver
- ▶ To avoid any risk, do not make any changes to the shaver or accessories.
- ▶ Any servicing or repair must be performed by Wahl (UK) Ltd or a suitably qualified professional.
- ▶ The use of attachments that are not supplied by the manufacturer may cause fire, electric shock or injury and damage to the appliance.



Danger! Electric shock due to penetration of liquid.

- ▶ Do not use this device – with the charger connected – in the vicinity of bathtubs, showers, washbasins or other vessels containing water.
- ▶ Protect the cable and the charger from moisture, dripping water or splash water.
- ▶ Do not operate the device with the charger connected if your hands are wet.
- ▶ Do not immerse the cable and the charger in water or other liquids or rinse them under running water.
- ▶ Unplug the charger from the power point before

- cleaning the shaver and its parts under running water.
- ▶ If the device has fallen into water, pull out the charger immediately, and only then remove the device from the water. Do not use the device again, but have it checked by a specialist.
 - ▶ If the device is used in a bathroom, the cord connecting the device to the mains power must be pulled out after use, as the proximity of water represents a hazard, even when the device is switched off.
 - ▶ Installation of a residual current device (FI/RCD) with a rated residual operating current of no more than 30 mA is recommended to provide additional protection.
 - ▶ Ask your electrician for advice. The installation should only be carried out by a qualified electrician.



Danger of explosion

- ▶ Protect rechargeable batteries against mechanical damages. Danger of fire.
- ▶ Do not expose the shaver to direct sunshine or heat. The ambient temperature should not be lower than 5 °C or higher than 35 °C.
- ▶ The charge contacts on the shaver must not be connected by metallic objects. Rechargeable batteries may overheat and explode.
- ▶ Charge the shaver only with the charger provided.
- ▶ Should the electrolyte solution leak out of the rechargeable batteries, avoid contact with eyes,

SHAVER

mouth, nose and skin. Rinse immediately with plenty of clean water and consult a doctor. The electrolyte solution can cause irritation.



Warning! Injuries due to incorrect handling

- ▶ Place the cable in such a way that no one trips over it or steps on.
- ▶ Do not use the device on open wounds, cuts, sunburn or blisters.
- ▶ Do not operate the shaver if the device or cutting elements are damaged or defective.
- ▶ The cutting blades are sharp. Handle with care.
- ▶ Keep the shaver away from your eyes.
- ▶ Always switch off the shaver before cleaning it.



Caution! Danger of product damage

- ▶ Use the original accessories only.
- ▶ Never place the shaver on hot surfaces (e.g. hob plates) or near heat sources or open fire.
- ▶ Do not cover the charger to prevent overheating.
- ▶ In order to avoid damages to the shaving foil, do not exert excessive pressure on the shaving foil.
- ▶ Do not use any harsh or abrasive cleaning agents.



NOTE: We advise you not to use shaving gel, since this may cause the shaving foil and cutting blades to stick to each other.

SHAVER

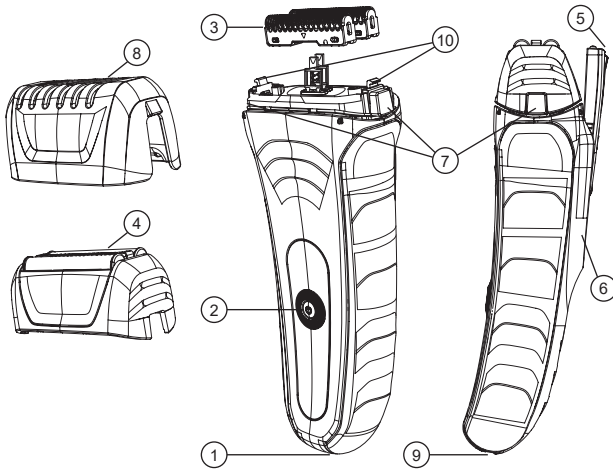

DESCRIPTION OF PARTS

1. Charge socket
2. On/off switch
3. Cutter bar assembly
4. Flex foil head
5. Long hair pop up trimmer
6. Long hair trimmer switch
7. Shaver head release button
8. Foil guard
9. Charger contacts
10. Spring clip

NOTE: Remove LED label before first use.

SHAVER

OPERATING INSTRUCTIONS

TIPS FOR FIRST-TIME USERS

If you are using an electric shaver for the first time, your skin will probably need to condition itself to this new shaving technique.

Start on the easiest part of the face first, usually the smooth portion of the face below the ear. Shave with a light touch and use your Wahl Shaver exclusively for three to four weeks, or longer if you have sensitive skin or if your whiskers grow at different angles in certain areas. Initially your shaves may not be as close as you would like, and your skin may become a bit irritated. But if you stick with it, you will eventually get great shaves.

If you go several days without shaving and your beard gets a bit long, use the pop-up trimmer to go over your beard, catching all the longer hairs and setting up the remaining stubble for the foil to shave smooth and clean.

If you have been using another type of electric shaver before, there may also be a period of conditioning prior to receiving maximum results.

QUICK TIPS & HANDY REMINDERS

1. If you are a first-time electric shaver user, or changing from another brand, there will be a 2 to 3 week (or less) adjustment period while your face and beard adapts to the new foil.
2. When you open your package, charge your shaver for 1 hour before the first shave or until charging is complete.
3. Replace the foil head and cutter bars every 12 months or if foils are damaged. Replacement foils can be ordered by contacting WAHL customer Services.

SHAVER

4. Be sure to clean the shaver, cutter bars and foil after every three or four shaves.
5. Use the pop-up long-hair trimmer to snip stray hairs.
6. Keep using and both your face and beard will adapt to the shaver.

TRAVEL LOCK

The Wahl Shaver comes with an electronic travel lock to avoid accidental activation while transporting.

Hold power button down for 3 seconds to engage travel lock.

Hold power button down for 3 seconds to disengage travel lock.

When travel lock is active, pressing the power button will cause the LED(s) to flash for 1 second.

- i NOTE:** The shaver will not charge while the travel lock is engaged

CHARGING OPERATION

The shaver cannot be overcharged, so you may charge it as often as desired. However, periodic recharging of the shaver, rather than continuous recharging, will prolong battery life.

60 minutes charge time will provide you with 90 minutes cordless operation.

MODELS WITH 1 LED

Charge when shaver seems to lose power or run slower. The charging LED will light up while charging. LED will turn off when charging is complete.

MODELS WITH 2 LEDS

The red LED will flash for one second when turning off the shaver when it is time to charge (below 10%).

The blue LED will light up while charging. LED will turn off when charging is complete.

SHAVER

MODELS WITH 5 LEDS

The LED meter will show the amount of charge left on the shaver. The fewer lights that are lit, the lower the charge on the battery is. The red LED will flash for one second when turning off the shaver when it is time to charge (below 10%). While charging, the LED meter will show the progression of charging. All LEDs will turn off when charging is complete.



WARNING. Do not operate the shaver if the shaving foil is damaged.

SHAVING PROCEDURES FOR FAST, CLOSE SHAVES

We suggest that you thoroughly cleanse and completely dry your skin prior to shaving. For maximum speed and efficiency, hold the shaver so that both screens are in contact with the skin. When shaving the upperlip or neck, hold shaver so that the uppermost screen is in contact with skin.

Shave both with and against the grain of the beard, and stretch the skin taut in the path of the shaver. Guide the dual foil heads **gently** back and forth, primarily against the grain of the beard. **Do not press screen heads hard against face.** Heavy scrubbing action with the shaver could damage the foil and will not result in a closer shave. Always replace the foil guard to protect the delicate dual foil heads when shaver is off.



SHAVER

SHAVING HEAVY BEARD GROWTH

Begin shaving in a less dense area of the beard. Move the shaver in a circular motion on a small area of the face (this picks up the hairs that grow in all directions).

When you see that this small area is shaved clean, gradually move into a new area while still using the circular motion. Continue this motion, one small section at a time, until entire face is shaved.

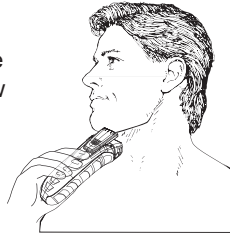

If your beard has more than 3 days of growth, use the pop-up Long-Hair Trimmer to cut the beard down to about a one-day growth before using the shaver foil.

LONG-HAIR TRIMMER OPERATION

Your shaver features a special long-hair trimmer located on the back of the shaver which telescopes up from the foil head for precise and easy trimming of sideburns, beards or moustaches, and for removing long hairs from the neck. And, as mentioned earlier, it can be used to “knock down” heavy beard growth prior to shaving with the foil.



To use, remove Foil Guard and simply push the Long-Hair Trimmer Switch in an upward motion until trimmer slides (clicks) into position. Push On/Off Switch. Then begin trimming/styling

SHAVER

CLEANING AND MAINTENANCE SHAVER HEAD CARE

For maximum performance, we recommend you clean your shaver after every few shaves. Any servicing, other than replacement of foil head and cutter bars, should be performed by an authorised Wahl Service Center or Wahl customer services.

To clean, turn shaver “OFF” and remove the foil head by pushing the shaver head release buttons on the sides of the shaver and lifting the foil head upward.

Lightly tap the open side of the foil head on a hard surface to remove the majority of loose stubble particles.

Be careful not to tap the foil.

For easy cleaning, you may rinse your shaver with water.

While the foils can be rinsed, we recommend removing the foil head, and rinsing the cutter bars. This will allow any hairs still on the cutter bars to be washed away. Leaving the foil head on while rinsing makes it more difficult for hairs to be washed clean.

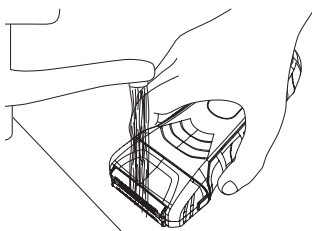
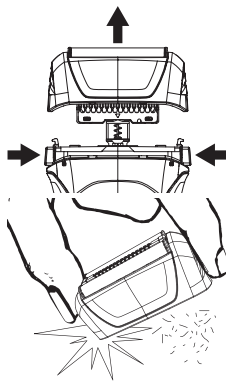

SHAVER

TO REMOVE CUTTER BAR

Turn shaver off. Remove the foil head and, holding the shaver in one hand, gently pull up on cutter bar. Be sure your thumb and first finger are positioned at each end of the cutter bar.

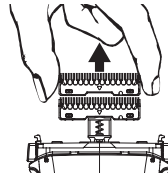

⚠ WARNING: Handle cutting components with care to avoid personal injury.

i NOTE: If you do not hold the cutter bar as shown, brushing the blades could result in damage to the assembly.

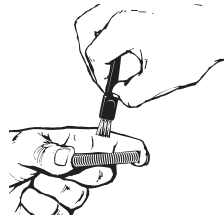

When the foil head and cutter bars are removed from the shaver, an alternate cleaning method is to rinse them under running water. Simply let them air dry. After cleaning, replace the cutter bars by pressing down gently. Carefully replace the foil head, snapping it into place.

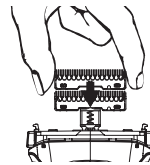

From time to time, depending on the density of your beard, you will need to replace the cutters and foils. If you notice that it is taking you longer to shave, or if your face starts to feel some irritation, or if the foil seems to become warm to the touch, it is probably time to replace the cutters and foils. Replace the cutters and foils only with WAHL parts. Please contact Wahl customer services for replacement.

SHAVER

OILING THE FOILS & CUTTER BAR

Oil lubrication helps maintain smooth blade movement and shaving performance. If the shaver is regularly cleaned under water. The Foils should be oiled at least once per week. Use clipper oil or shaver oil.

Instructions: When foils and blades are clean and dry, apply a drop of oil to the top of each foil and on top of the center cutter bar. Use finger to gently spread the oil over the surface. Turn the shaver on for 10 seconds to help distribute the oil onto the blades below. Turn off shaver and use a tissue or soft cloth to wipe any excess oil from the surface.

CLEANING & OILING TRIMMER BLADES

Clean with the included brush. For best results, put one or two drops of blade oil on the blades only when necessary, or approximately once a month.

Motor bearings are permanently lubricated—do not attempt to oil. When oiling your shaver, turn the shaver “ON - I,” hold the unit with the blades facing DOWN and squeeze one or two drops of oil onto the blades. Wipe off excess oil with soft cloth.

Blade oil can be purchased from Wahl customer services.

i NOTE: DO NOT OVER OIL!

Excessive oiling or application of liquids will cause damage if allowed to seep back into motor.

FOIL & BLADE CARE

Trimmer blades have precision-hardened, ground and lapped cutting teeth. Foils, cutter bar, and blades should be handled carefully and never bumped or used to cut dirty or abrasive material.

STORAGE

Before storing your shaver, use the cleaning brush to whisk any loose hairs from the unit, foils, cutter bar, and blades. Store unit in such a manner so that blades are protected from damage. When the shaver is not in use, the shaver foil/blade guard attachment should be in place to protect the blades.

This appliance should be stored in a manner where it is not subjected to crushing, heating above 100°C (212°F), or incineration.

CORD CARE

The cord should not be used to pull the shaver. Freedom of movement needs to be maintained. Care should be used to keep the cord untwisted and undamaged.

When stored, the cord should be coiled and replaced neatly in its original package or storage pouch.

WET/DRY USE

- i NOTE:** Do not submerge shaver in more than 3 feet of water or for more than 30 minutes to prevent water ingress into the electronics.

Warranty is void if shaver is submerged beyond these limitations.

The Wahl shaver is designed to be water resistant and shower proof (IPX7). This lets you use your Wahl shaver in the shower or at the sink without worry and makes it easy to clean under running water.

- i NOTE:** The shaver is for wet/dry use. The shaver will not run while the cord is attached for safety.

SHAVER

TROUBLESHOOTING



WARNING!

Do not attempt to repair the shaver yourself.

- Always remove the charger from the socket whenever a fault occurs.

Fault	Please check the following
No function	Is there power to the power point? Batteries low?
The shaving performance deteriorates	Clean the cutting bar, if needed replace the foil and cutter bar.

If you are experiencing a fault which is not listed here, please do not hesitate to contact our Customer Services. Repairs must only be carried out by qualified technicians or by our Service Centre.

LITHIUM-ION BATTERY REPLACEMENT REMOVAL AND DISPOSAL

For battery replacement the entire, intact clipper or trimmer should be sent to: Wahl (UK) Ltd Customer Services (the address can be found on the reverse of this booklet) or taken to a suitably qualified professional. The battery should only be replaced by the original manufacturers spare, for safety reasons a substitute should not be used.

Do not attempt to remove the battery. Lithium-Ion batteries can explode, catch fire, and/or cause burns if disassembled, damaged or exposed to water or high temperatures.

LITHIUM BATTERY DISPOSAL

Do not dispose of this product or the Lithium battery in the normal household waste.

The product should be returned to Wahl Customer Services where we offer a take back service or taken to a local collection facility where they will be dealt with safely and sent for the appropriate recycling.

SHAVER

WIRING



WARNING: THIS PRODUCT MUST ONLY BE USED WITH THE TRANSFORMER SUPPLIED. SHOULD A REPLACEMENT BE REQUIRED CONTACT WAHL CUSTOMER SERVICE ON 01227 740066.



DISPOSAL

Handle with care! Environmental damage in the case of incorrect disposal.

Correct disposal will ensure environmental protection and prevent any potentially harmful impacts on people and the environment.

Adhere to the relevant legal requirements when disposing of the appliance. Information on the disposal of electrical and electronic appliances in the European Community:

SHAVER

**WASTE ELECTRICAL & ELECTRONIC EQUIPMENT
DIRECTIVE 2002/96/EC (WEEE)**



At the end of this products life it should not be disposed of with general household waste. Care should be taken to dispose of in a suitable manner in accordance with your Local Authority regulation.



SHAVER

GUARANTEE

This product is guaranteed against defects in material and workmanship for a period of 5 years from the date of original purchase or receipt as a gift.

Should this product become defective during the guarantee period, return it to the store of purchase together with your proof of purchase for repair or replacement.

Alternatively within the guarantee period you can return the product to Wahl (UK) Ltd who will repair any such defect or elect to replace the product or any part of it, without charge, provided that there is proof of purchase. Should a replacement be offered this will not extend the original guarantee period.

The guarantee becomes invalid in the case of misuse, alteration or repair by unauthorised persons.

This guarantee does not include blades, cables, shaver heads, foils and cutters etc which are consumable parts.

This product is designed for domestic use only and use within a professional environment will invalidate the guarantee.

This guarantee in no way affects your rights under statutory law in the United Kingdom.

SHAVER

WAHL (UK) LIMITED
STERLING HOUSE,
CLIPPER CLOSE,
RAMSGATE, KENT
CT12 5GG

CUSTOMER SERVICES T: 01227 740066
www.wahl.co.uk

Form No. 91590-100
Rev1 07-18