



P R O F E S S I O N A L

ANIMAL CLIPPERS AND TRIMMERS

INSTRUCTIONS

TABLE OF CONTENTS

IMPORTANT SAFEGUARDS	3
USEFUL INFORMATION ABOUT YOUR PRODUCT	5
BLADES	5
PRODUCT INSTRUCTIONS	
MAINS CLIPPERS	
MAX 45 - KM6245 / WM6245	
MAINS POWERED CORDED CLIPPER	6
KM5 / KM10 - WM6260 / WM6261	
MAINS POWERED DOG CLIPPER	10
POWER GRIP - 8879	
MAINS POWERED DOG CLIPPER	14
ARCO - WM6854	
RECHARGEABLE DOG CLIPPER	18
BRAVURA - WM6870	
CORD/CORDLESS DOG CLIPPER	22
TRIMMERS	
BRAVMINI - WM6590	
RECHARGEABLE DOG TRIMMER	27
MINI ARCO - WM6565	
CORD/CORDLESS DOG TRIMMER	30
STAINLESS STEEL BLADES AND COMBS	32
BATTERY REPLACEMENT, REMOVAL & DISPOSAL	33
WIRING & DISPOSAL	34

These clippers and trimmers are designed for use in commercial dog grooming environments.
Save these instructions for future reference.

Please read all instructions carefully to familiarise yourself
with the product before using.

For any further assistance or information call Customer Services on

T: 01227 740066

or visit

W: www.wahl.co.uk

E: customer.services@wahl.co.uk

IMPORTANT SAFEGUARDS

When using your electrical appliance, basic safety precautions should always be followed, including the following:

REQUIREMENTS

- ▶ Read the instruction manual in full to familiarise yourself with the product before the first use.
- ▶ This appliance can be used by children from aged 14 years and above and persons with reduced physical, sensory or mental capabilities, or lack of experience and knowledge, if they have been given supervision or instruction concerning use of the appliance in a safe way and understand the hazards involved. Children shall not play with the appliance. Cleaning and user maintenance shall not be made by children without supervision.
- ▶ Use this appliance only for its intended purpose.

HAZARDS



Danger! Electric shock due to damage to appliance

- ▶ Do not operate the appliance with a broken cord, plug or charger, or if the appliance malfunctions, or is dropped or damaged in anyway.
- ▶ Any servicing or repairs must be performed by an authorised service representative.
- ▶ The use of attachments that are not supplied by the manufacturer may cause fire, electric shock or injury and damage to the appliance.



Danger! Electric shock due to penetration of liquid

- ▶ To protect against risk of electrical shock, never immerse the unit or let it come into contact with water or any other liquids. Do not use the unit with wet hands. If the appliance should become wet, damp or fall in water, remove plug from mains socket immediately. Do not put your hands in the water. Do not take into bathroom.



Danger of explosion

- ▶ Never use the appliance where aerosol (spray) products are being used or where oxygen is.
- ▶ Do not expose the appliance to temperatures below 0°C and above +40°C for any length of time. Avoid direct exposure to sunlight.



Warning! Injuries due to incorrect handling

- ▶ Cutting blades may become hot after prolonged use.
- ▶ Switch off the appliance and unplug from outlet when not in use, before putting on or taking off attachments and also before cleaning the appliance.
- ▶ Never use your appliance without paying attention! Except when charging always unplug this appliance from the electricity outlet immediately after using.
- ▶ These appliances are intended for animal hair trimming and clipping only.



Caution! Danger of product damage

- ▶ Do not wrap the cord around the appliance.
- ▶ Do not use outdoors or in damp areas.
- ▶ Never carry the unit by its power cord.
- ▶ Do not drop or insert any object into any opening.

Covers all models:

Emission sound pressure level: max. <70 dB(A)

Vibration: < 2,5 m/s²

USEFUL INFORMATION ABOUT YOUR PRODUCT

Essential information

For maximum efficiency, durability and satisfaction from Wahl clippers and trimmers, please note the following points:-

- Regularly apply a few drops of oil to the blades during clipping/trimming. Clipper oil lubricates the blades and will ensure your clippers or trimmers perform to their maximum capacity. Without oil, friction is increased therefore generating heat. If blades are getting hot then insufficient oil is being applied or the blades need cleaning or sharpening.
- Always ensure the animal coat is dry, as clean as possible and brushed to remove tangles, grease and dirt particles from the hair.
- During operation, take time to regularly brush hairs and dirt from the blades.
- We recommend use of Wahl Hygienic Spray to ensure grease and dirt particles are flushed from the blade surface. DO NOT use water to clean the blades.
- Always oil the blades after cleaning.
- Always clean your machine and blades thoroughly when you have finished clipping. Do not separate the top and bottom blade when cleaning.
- If your product has an air filter ensure it is clear of obstructions to avoid overheating the motor.
- Whenever storing your appliance, disconnect all cables and store your clipping/trimming kit in a dry, temperate environment.
- Always oil your blades before use and before storage to prevent atmospheric moisture causing damage to the blade surface.

BLADES

The blades are the single most important part of a clipper or trimmer and must be well maintained at all times for maximum cutting performance.

Cutting hair does not blunt the blades. Abrasive particles on the animal's hair, such as dirt, sand, grease, etc will blunt the blades.

Blades will not cut if abrasive particles are picked up and carried by the oil film between the blades. These particles tend to separate the blades from each other and pull the hair as opposed to cutting it cleanly. Keeping your blades well oiled performs the following important functions:-

- Provides a low friction, very thin film lubricant between the cutting blades so the blades can take a full cutting stroke without becoming hot from frictional heat.
- Flushes abrasive particles and hairs out from between the blades.

If you cut into dirt, immediately clean your blades with Wahl Hygienic Spray or Wahl Clipper Oil to flush out the dirt. ALWAYS apply clipper oil after cleaning with hygienic spray or coolant.

MAX 45 - CORDED DOG CLIPPER

Model: MAX 45 - KM6245 / WM6245

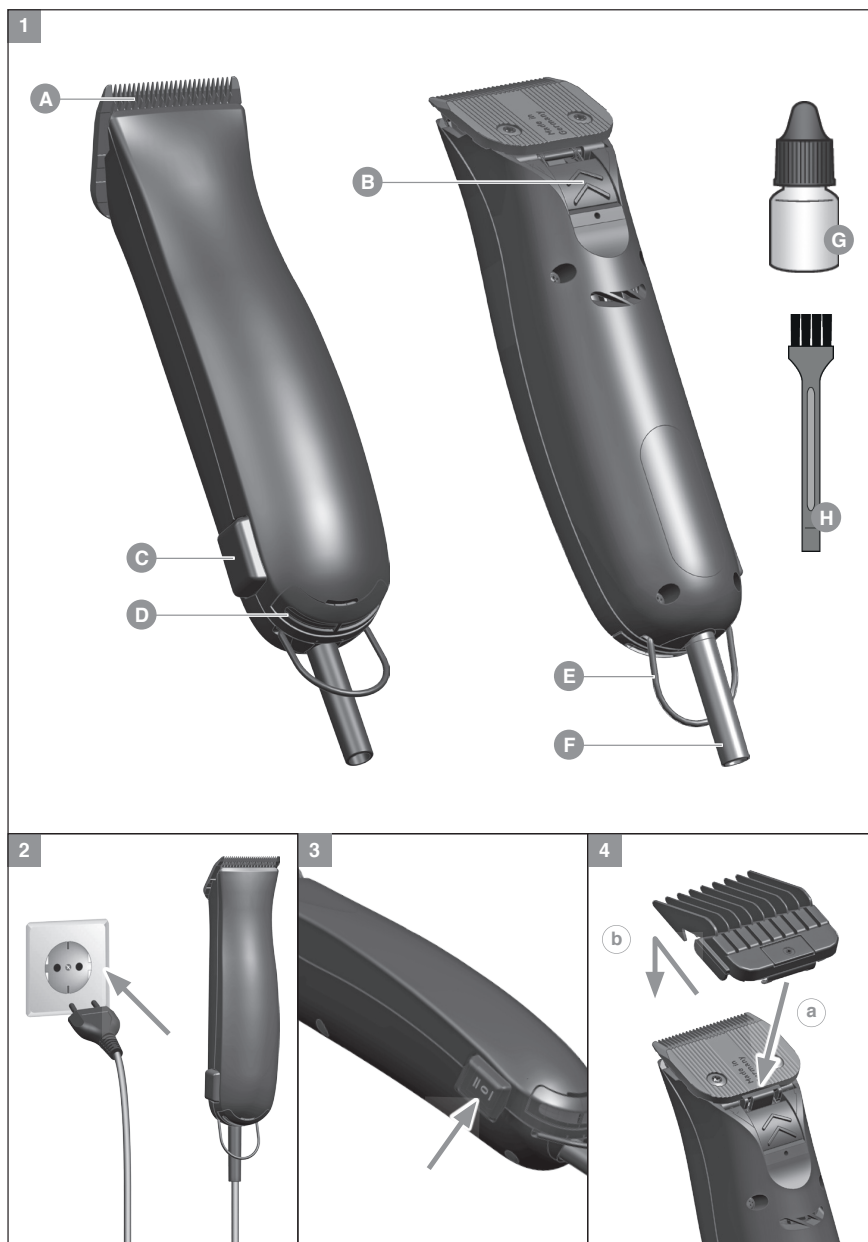



Model: **MAX 45 CORDED DOG CLIPPER - KM6245 / WM6245**

Description of parts (Fig. 1)

- A. Blade set
- B. Release button for blade set
- C. On/off switch
- D. Air filter
- E. Hang-up loop
- F. Mains cable
- G. Oil for blade set
- H. Cleaning brush

Mains Operation

1. Connect to the mains power supply (Fig. 2)
2. Switch on the appliance using the on/off switch and switch off after use (Fig. 3).
The appliance has two speed settings.
These can be selected via the on/off switch.
Setting I = slow speed
Setting II = high speed

Cutting with the attachment comb

The appliance can also be operated with attachment combs. Attachment combs can be used to extend the cutting length range.

For best results we recommend using a #30 or #10 blade with the comb attachments. Accessories are available from your local dealer.

Attaching / removing the attachment comb

1. Fit the attachment comb onto the bottom edge of the blade set (Fig. 4a) and push it over the cutting edge of the bottom blade until it locks (Fig. 4b).
2. Push the attachment comb towards the cutting edge of the bottom blade (Fig. 5) and remove it from the blade set.

Changing the blade set

To remove a blade set:

1. Switch off the appliance using the on/off switch (Fig. 3).
2. Press the release button (B) (Fig. 6a) towards the blade set and lift the blade set away from the housing (Fig. 6b).
3. Remove the blade set from the clip (Fig. 6c).

To attach a new blade set:

1. Attach the new blade set onto the clip (Fig. 8a).
2. Ensure that the clip is folded out. If this is not the case, you can fold out the clip with a flat screwdriver (Fig. 7).
3. Push the blade towards the machine to snap into place.
4. If the blade fails to engage, switch the appliance on (Fig. 3), then push the blade set against the hand-held appliance until it audibly clicks into place and the blade moves (Fig. 8b).

Remove the attachment comb (Fig. 5) after every use and lift the blade set out of the casing (Fig. 6). Use the cleaning brush to remove any cut hairs from the housing opening and from the blade set (Fig. 9).



Caution! Injuries due to incorrect handling.

The blade set must not be unscrewed. The top blade must not be pushed out completely!

- Push the top blade to the side (Fig. 9a) and remove cut hairs from the top and bottom blade using the cleaning brush.
- After cleaning, return the top blade to its initial position (Fig. 9b). The top blade should be aligned in the centre of the bottom blade. After cleaning the blade set, we recommend using hygienic spray. It keeps all blade sets hygienically clean and is effective against bacteria and viruses.

- Oil the blade set with the blade set oil (Fig. 10).
- We recommend that you clean and care for your blade set during and after clipping.
- Re-attach the blade set after cleaning (Fig. 7/8). Switch the appliance on briefly (approx. 10 seconds) to ensure the oil film is evenly distributed.
- For a good and long-lasting cutting performance, it is important to oil the blade set frequently.
- If the cutting performance deteriorates after long use despite regular cleaning and oiling, the blade set should be replaced.

Clean the air filter regularly to ensure the supply of air:

1. Detach the filter cover using a blunt lever and remove from the housing (Fig. 11a)
2. Clean the air filter using the cleaning brush.
3. Push the filter cover into the housing until it locks into position (Fig. 11b).
4. Only wipe the appliance with a soft, slightly damp cloth. Do not use solvents or abrasives.

PROBLEM ELIMINATION

Blade set is cutting badly or pulling hair out.

Cause: Blade set is dirty, worn out or blade is blunt.

- Clean and oil the blade set (Fig. 9/10);
if this does not resolve the problem, replace the blade set (Fig. 6/7/8).

Skin injury

Cause: Too much pressure on the skin.

- Reduce pressure when cutting close to skin.

Cause: Damaged blade set.

- Check whether the blade edges, or teeth are damaged and replace the blade set if necessary.
- NEVER use a damaged blade as this will cause injury.

Appliance is not working

Cause: Defective power supply.

- Make sure that contact between the mains and the socket is faultless. Check the mains cable for possible damage.

In the event that this information does not help you resolve your problem, please contact our Customer Service team. Never attempt to repair the appliance yourself!

KM5 - CORDED DOG CLIPPER KM10 - CORDED DOG CLIPPER

Model: KM5 - WM6260 KM10 - WM6261





Model: **KM5 - CORDED DOG CLIPPER WM6260**
KM10 - CORDED DOG CLIPPER WM6261

Description of parts (Fig. 1)

- A. Blade set
- B. Release button for blade set
- C. On/off switch
- D. Hang-up loop
- E. Mains cable
- F. Cleaning brush
- G. Oil for blade set
- H. Plug-in transformer

Mains Operation

1. Connect to the mains power supply (Fig. 2)
2. Switch on the appliance using the on/off switch (Fig. 3a) and switch off after use (Fig. 3b).
The appliance has two speed settings.
These can be selected via the on/off switch.
Setting I = slow speed
Setting II = high speed

Cutting with the attachment comb

The appliance can also be operated with attachment combs. Attachment combs can be used to extend the cutting length range.

For best results we recommend using a #30 or #10 blade with the comb attachments.
Accessories are available from your local dealer.

Attaching / removing the attachment comb

1. Fit the attachment comb onto the bottom edge of the blade set (Fig. 4a) and push it over the cutting edge of the bottom blade until it locks (Fig. 4b).
2. Push the attachment comb towards the cutting edge of the bottom blade (Fig. 5) and remove it from the blade set.

Changing the blade set

To remove a blade set:

1. Switch off the appliance using the on/off switch (Fig. 3).
2. Press the release button (B) (Fig. 6a) towards the blade set and lift the blade set away from the housing (Fig. 6b).
3. Remove the blade set from the clip (Fig. 6c).

To attach a new blade set:

1. Attach the new blade set onto the clip (Fig. 8a).
2. Ensure that the clip is folded out. If this is not the case, you can fold out the clip with a flat screwdriver (Fig. 7).
3. Push the blade towards the machine to snap into place.
4. If the blade fails to engage, switch the appliance on (Fig. 3), then push the blade set against the hand-held appliance until it audibly clicks into place and the blade moves (Fig. 8b).

Remove the attachment comb (Fig. 5) after every use and lift the blade set out of the casing (Fig. 6).
Use the cleaning brush to remove any cut hairs from the housing opening and from the blade set (Fig. 9).



Caution! Injuries due to incorrect handling.

The blade set must not be unscrewed. The top blade must not be pushed out completely!

- Push the top blade to the side (Fig. 9a) and remove cut hairs from the top and bottom blade using the cleaning brush.
- After cleaning, return the top blade to its initial position (Fig. 9b). The top blade should be aligned in the centre of the bottom blade. After cleaning the blade set, we recommend using hygienic spray. It keeps all blade sets hygienically clean and is effective against bacteria and viruses.
- Oil the blade set with the blade set oil (Fig. 10).
- We recommend that you clean and care for your blade set during and after clipping.

- Re-attach the blade set after cleaning (Fig. 7/8). Switch the appliance on briefly (approx. 10 seconds) to ensure the oil film is evenly distributed.
- For a good and long-lasting cutting performance, it is important to oil the blade set frequently.
- If the cutting performance deteriorates after long use despite regular cleaning and oiling, the blade set should be replaced.

Clean the air filter regularly to ensure the supply of air:

1. Clean the air filter using the cleaning brush.
2. Only wipe the appliance with a soft, slightly damp cloth. Do not use solvents or abrasives.

PROBLEM ELIMINATION

Blade set is cutting badly or pulling hair out.

Cause: Blade set is dirty, worn out or blade is blunt.

- Clean and oil the blade set (Fig. 9/10);
if this does not resolve the problem, replace the blade set (Fig. 6/7/8).

Skin injury

Cause: Too much pressure on the skin.

- Reduce pressure when cutting close to skin.

Cause: Damaged blade set.

- Check whether the blade edges, or teeth are damaged and replace the blade set if necessary.
- NEVER use a damaged blade as this will cause injury.

Appliance is not working

Cause: Defective power supply.

- Make sure that contact between the mains and the socket is faultless. Check the mains cable for possible damage.

In the event that this information does not help you resolve your problem, please contact our Customer Service team. Never attempt to repair the appliance yourself!

POWER GRIP CORDED DOG CLIPPER

Model: Power Grip - 8879

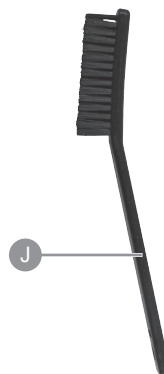

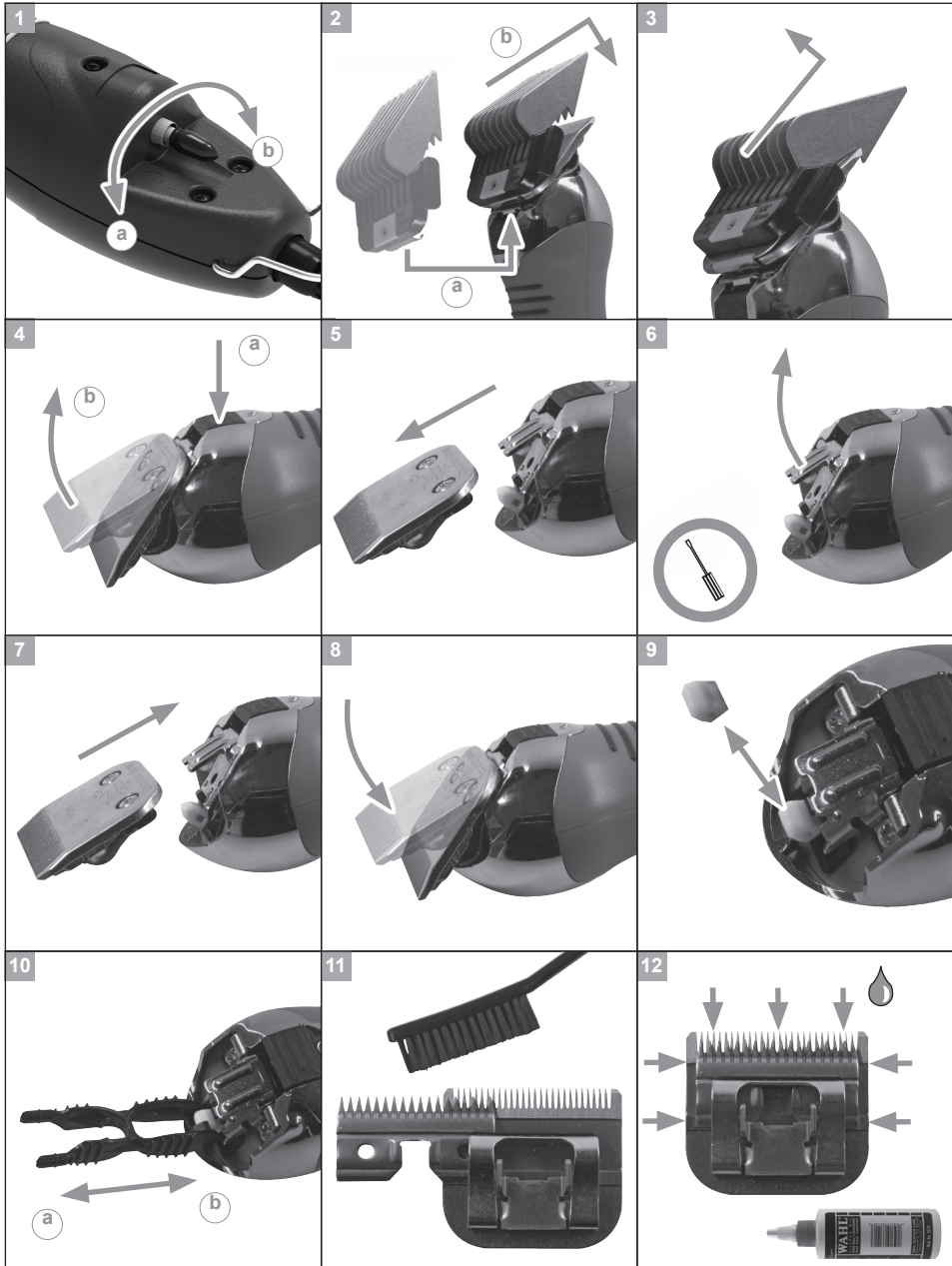

Model: **POWER GRIP - CORDED DOG CLIPPER - 8879**

Description of parts (Fig. 1)

- A Blade set
- B Release button for blade set
- C On/off switch (2 speed)
- D Hang-up loop
- E Mains cable
- F Clip for blade set
- G Replaceable drive lever tip
- H Special tool
- I Oil bottle
- J Cleaning brush

Mains Operation

1. Before starting the appliance, always oil the blade set (Fig. 12).
2. Only connect the appliance to the socket while it is switched off.
3. Connect the mains plug to the socket.
4. Switch on the appliance using the on/off switch (Fig. 1).
5. The appliance is equipped with 2 speed settings. These can be selected via the on/off switch. Setting 1a = standard speed, setting 1b = high speed.
6. After using the appliance, switch it off and remove the mains plug.

Cutting with the attachment comb

The appliance can also be operated with attachment combs. Attachment combs can be used to extend the cutting length range. Accessories are available from your dealer.

For best results we recommend using a #30 or #10 blade with the comb attachments.

Accessories are available from your local dealer.

Attaching / removing the attachment combs

1. Fit the attachment comb onto the bottom edge of the blade set (Fig. 2a) and push it over the cutting edge of the bottom blade until it locks (Fig. 2b).
2. Push the attachment comb towards the cutting edge of the bottom blade (Fig. 3) and remove it from the blade set.

Changing the blade set

Replace a blunt or damaged blade set with an original spare part only. Spare parts can be ordered through your dealer or Customer Services.

Before replacing the blade set, switch the appliance off.

Lubricate the new blade set before attaching (Fig. 12).

Removing the blade set:

1. Press the release button (B) (Fig. 4a) towards the blade set and lift the blade set out of the housing (Fig. 4b).
2. Lift the blade set out of its clip (Fig. 5) and ensure that the clip remains folded out.

Attaching the blade set:

1. Attach the new blade set onto the clip (Fig. 8a).
2. Ensure that the clip is folded out. If this is not the case, you can fold out the clip with a flat screwdriver (Fig. 7).
3. Push the blade towards the machine to snap into place.
4. If the blade fails to engage, switch the appliance on (Fig. 3), then push the blade set against the hand-held appliance until it audibly clicks into place and the blade moves (Fig. 8b).

Replacing the drive lever tip

The drive lever tip (Fig. 9) is a wearable part. If necessary, it can be replaced in the following manner:

1. Remove blade set (Fig. 4/5).
2. Using the special tool (H) provided, grip the tip and pull off the drive lever (Fig. 10a).
3. Fit new tip to drive lever and press down firmly until it engages (Fig. 10b). For this task, only use the special tool (H) provided.

Cleaning and Care

- Disconnect from the mains before cleaning and maintaining the appliance.
- Do not immerse the appliance in water!
- After each use, remove the hair clippings from the blade set with the cleaning brush.
 - Only wipe the appliance with a soft cloth, which may be dampened slightly. Do not use solvents or abrasives!
 - The blade set can be cleaned with hygienic spray.
 - For a long-lasting, good cutting performance, it is important to oil the blade set frequently (Fig. 12).
- Only use Wahl blade oil.
- Blade set oil and hygienic spray are available from your dealer or our Customer Service team.
- We recommend oiling animal blades every 15 minutes during use.
- Remove the blade set (Fig. 4) and push the top blade to the side. Then remove cut hairs from the top and bottom blade by using the cleaning brush (Fig. 11).



Important note:

- The top blade must not be pushed out completely! The blade set must not be unscrewed.
- After cleaning, return the top blade to its initial position.
 - Oil the marked areas of the blade set with one drop of oil each (Fig. 12).
 - The top blade should be aligned in the centre of the bottom blade.
 - Reattach the blade set as described above. Switch the appliance on briefly (approx. 10 seconds) to ensure the oil film is evenly distributed.
 - If the cutting performance deteriorates after long use despite regular cleaning and oiling, the blade set should be replaced.

PROBLEM ELIMINATION

Blade set is cutting badly or pulling hair out.

Cause: Blade set is dirty, worn out or blade is blunt.

- Clean and oil the blade set (Fig. 9/10);
if this does not resolve the problem, replace the blade set (Fig. 6/7/8).

Skin injury

Cause: Too much pressure on the skin.

- Reduce pressure when cutting close to skin.

Cause: Damaged blade set.

- Check whether the blade edges, or teeth are damaged and replace the blade set if necessary.
- NEVER use a damaged blade as this will cause injury.

Appliance is not working

Cause: Defective power supply.

- Make sure that contact between the mains and the socket is faultless. Check the mains cable for possible damage.

In the event that this information does not help you resolve your problem, please contact our Customer Service team. Never attempt to repair the appliance yourself!

ARCO RECHARGEABLE DOG CLIPPER

Model: ARCO - WM6854

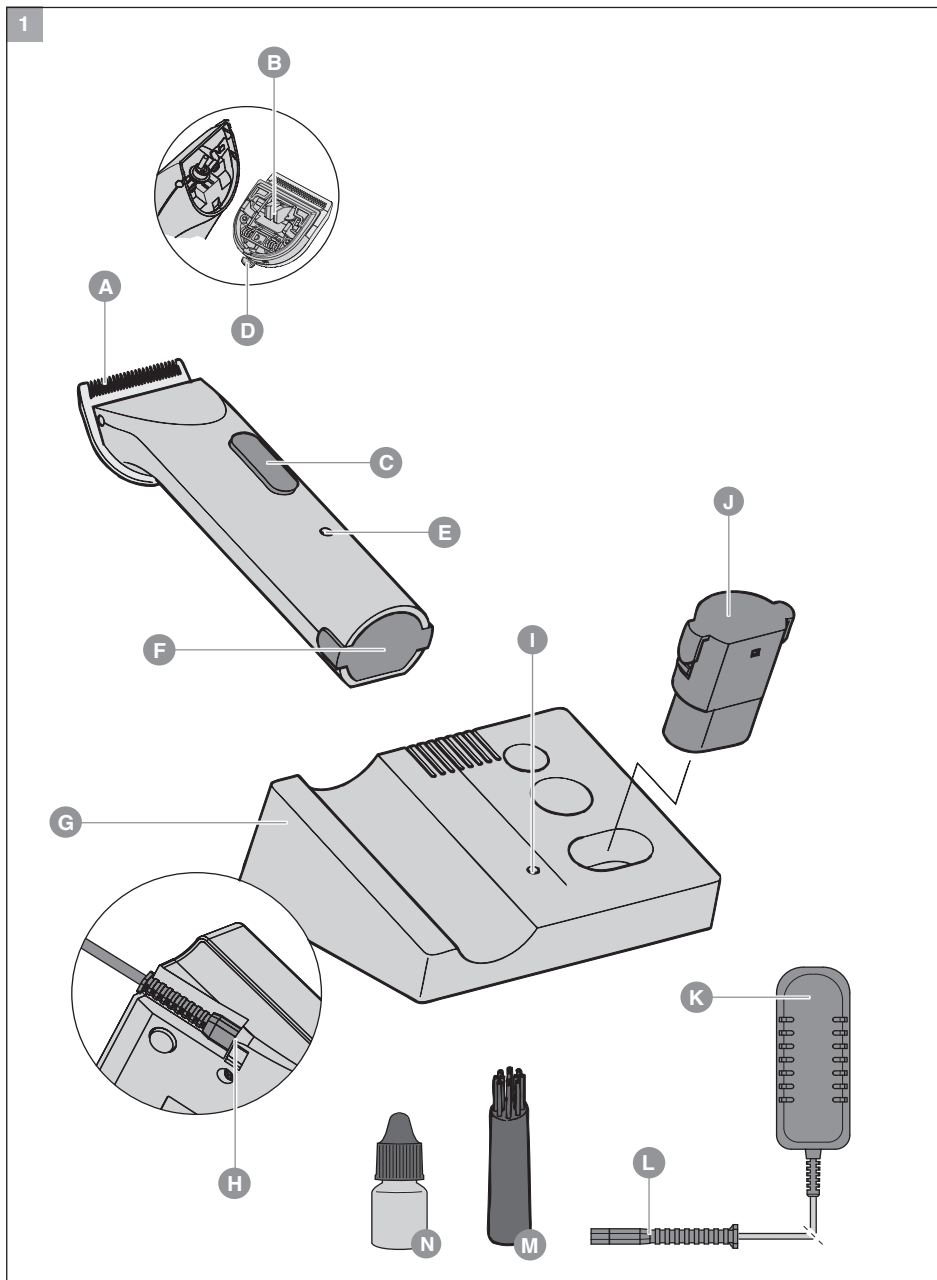

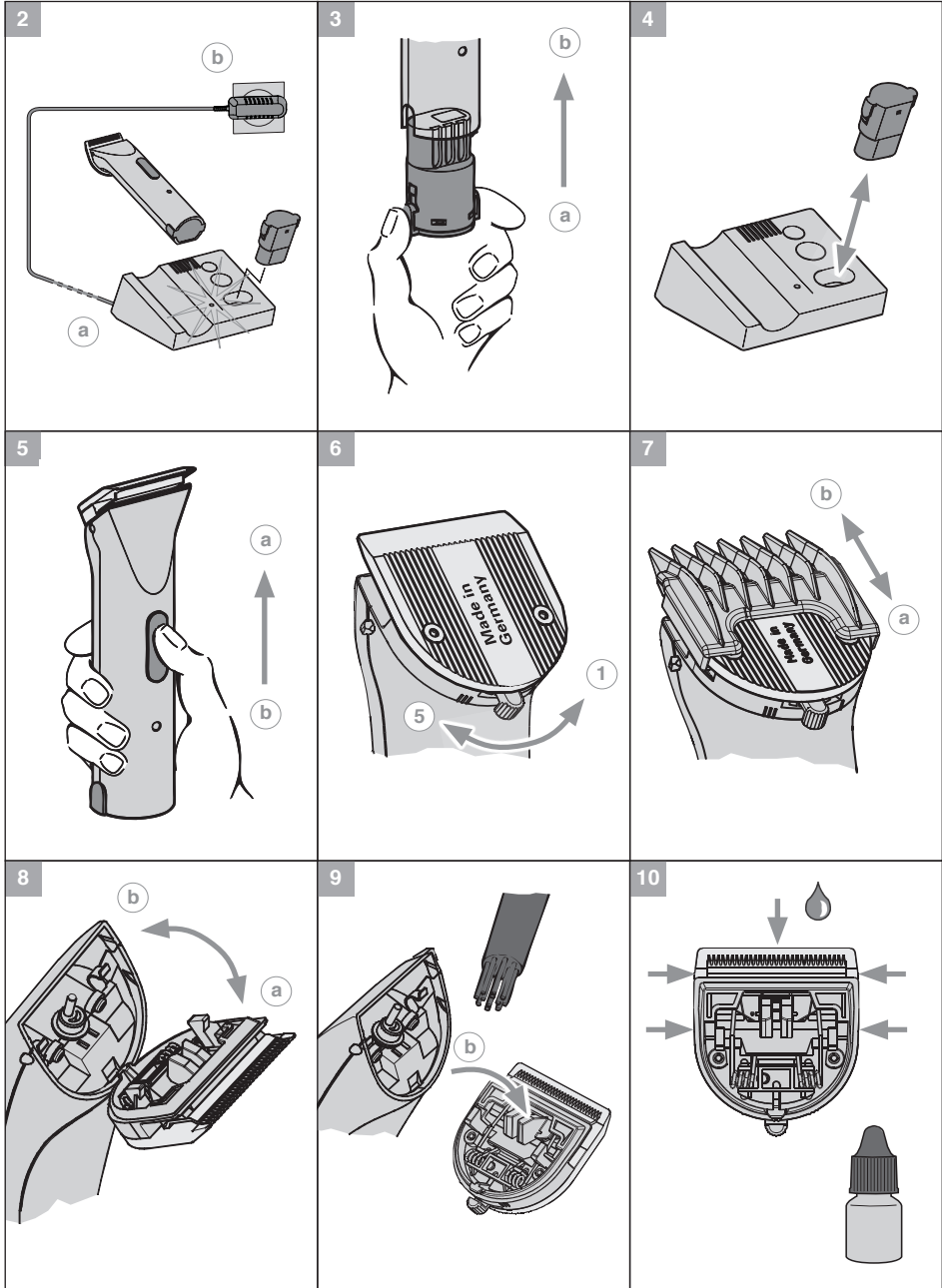

Model: ARCO RECHARGEABLE DOG CLIPPER - WM6854

Description of parts (Fig. 1)

- A. Blade set
- B. Cleaning lever
- C. On/off switch
- D. Cutting-length adjustment
- E. Battery charge indicator
- F. Battery pack
- G. Charging stand
- H. Charging stand socket
- I. Charging indicator
- J. Interchangeable battery pack
- K. Plug-in transformer
- L. Appliance plug
- M. Cleaning brush
- N. Oil for blade set

* Attachment combs are optional accessories and can vary from model to model.

Charging the battery

This cordless hair clipper is supplied with two battery packs. While the appliance is in use, the second battery pack can be recharged on the charging stand. This means that the clipper is always ready for use.

Before the appliance is used for the first time, each battery pack should be charged for approx 90 minutes.

1. Connect the appliance plug (L) on the plug-in transformer to the charging stand socket (H) (Fig. 2a).
2. Connect the plug-in transformer to the mains socket (Fig. 2b).
3. Insert the battery pack into the recess of the charging stand (Fig. 4). The charging process starts. During charging, the red charging indicator (I) is illuminated.
 - It should take around 75 minutes for the appliance to charge to full capacity.
 - The second battery can remain in the charging stand so that a charged battery pack is always available.
4. Once charging is complete, the charging indicator (I) on the charging stand (G) will start flashing.

Battery Operation

1. Switch on the appliance using the on/off switch and switch off after use (Fig. 5a/b).
 - When you press the on/off switch, the battery power indicator (E) will light up briefly to indicate that the appliance is ready for use.
 - The appliance can be operated for up to 80 minutes when the battery is fully charged.
 - Insufficient maintenance of the blade set can significantly reduce the operating life.
 - If the battery power indicator (E) on the hand-held appliance lights up during operation, this means there is only approx. 15% battery power remaining. The battery pack needs to be recharged. You can now use the charged replacement battery pack.

To recharge the battery:

1. Switch off the appliance using the on/off switch (Fig. 5b).
2. Press the unlock buttons on the side and remove the battery pack (Fig. 3a).
3. Remove the charged battery pack (Fig. 4) and push it into the appliance until you hear it snap into place (Fig. 3b).
4. Fit the flat battery pack to the charging stand (Fig. 4). **See Charging the battery**

OPERATION

Setting the cutting length

The cutting length can be adjusted to between 0.7mm and 3mm (5 possible positions) using the cutting-length adjustment integrated into the blade set (Fig. 6).

Cutting with attachment combs

The appliance can also be operated with attachment combs. In order to achieve the indicated cutting length, the cutting length adjustment lever should be set to position I (Fig. 6).

Attaching/removing the attachment comb

1. Slide the attachment comb on to the blade set in the direction of the arrow until it reaches the limit (Fig. 7a).
2. The attachment comb can be removed by pushing it in the direction of the arrow (Fig. 7b).

Maintenance, cleaning and care.

- Remove the attachment comb (Fig. 7b) after every use and lift the blade set out of the housing (Fig. 8a).
- Use the cleaning brush to remove any cut hairs from the housing opening and from the blade set (Fig. 9).
- The cleaning lever (Fig. 9b) can also be pressed. This allows the cut hairs that accumulate between the bottom blade and the top blade to be easily removed using the cleaning brush.
- Only wipe the appliance with a soft, slightly damp cloth
- The charging contacts on the charging stand and on the battery pack should always be kept clean.
- Clean the blade set regularly using hygienic spray.
- Oil the blade set with the blade set oil (Fig. 10)
- For long-lasting cutting performance, it is important to oil the blade set frequently.
- If the cutting performance deteriorates after long use despite regular cleaning and oiling, the blade set should be replaced.

Changing the blade set

Removing the blade set:

1. Switch the appliance off using the on/off switch (Fig. 5b) and disconnect from the power supply.
2. Slide the blade set off the housing in the direction of the arrow (Fig. 8a). Remove the blade set.

Replacing the blade set:

1. Replace the blade set by hooking it into the housing. The small lug at the base of the blade should be aligned with the indent on the clipper casing. Press the blade down until it clicks into position (Fig. 8b).

Problem elimination

Blade set is cutting badly or pulling hair out.

Cause: Blade set is dirty, worn or blunt.

- Clean and oil the blade set (Fig. 9/10); if this does not resolve the problem, replace the blade set (Fig. 8).

Skin injury

Cause: Too much contact pressure on the skin.

- Reduce contact pressure when cutting close to skin.

Cause: Damaged blade set.

- Check whether the blade edges or teeth are damaged and replace the blade set if necessary.
- NEVER use a damaged blade as this will cause injury.

Battery life is too short.

Cause: Blade set and housing opening are dirty.

- Clean and oil the blade set (Fig. 9/10).

Cause: Battery is worn out.

- Replace the battery pack with an original spare part.
- Replacement battery packs are available from your dealer or from our Customer Service team.

Charging indicator does not light up.

Cause: The battery pack is not correctly positioned on the charging stand.

- Ensure that the battery pack has been correctly placed on the charging stand.

Cause: Charging contacts are dirty.

- Clean the charging contacts on the charging stand and on the battery pack

Cause: Defective power supply.

- Ensure that the plug-in transformer is plugged into the mains socket.
- Check the mains cable for possible damage.

Battery Removal, Disposal and Replacement

For Removal instructions see page 33

BRAVURA CORD /CORDLESS DOG CLIPPER

Model: BRAVURA - WM6870

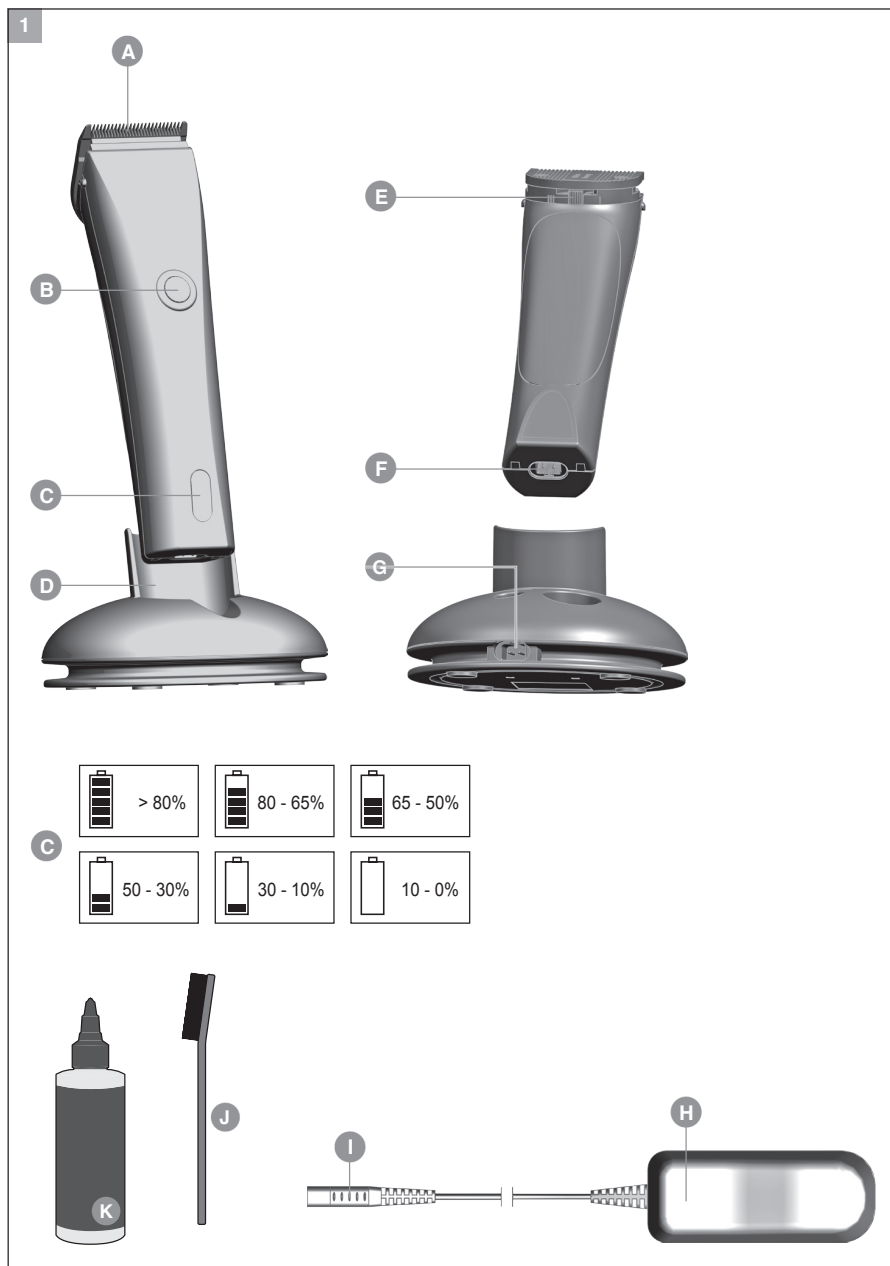

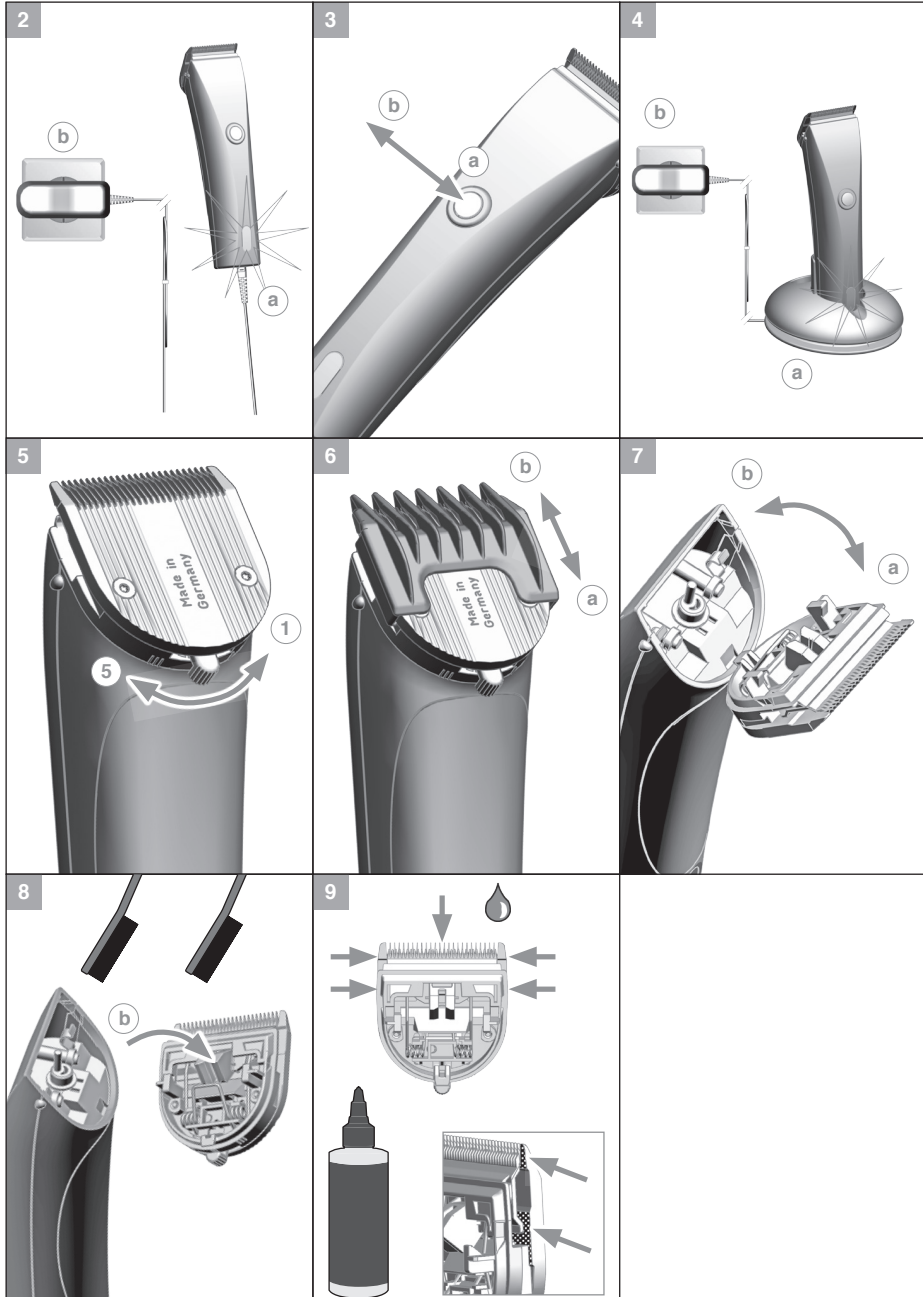

Model: **BRAVURA CORD / CORDLESS CLIPPER - WM6870**

Description of parts (Fig. 1)

- A. Blade set
- B. On/off switch
- C. Battery power indicator
- D. Charging stand
- E. Cutting-length adjustment
- F. Appliance socket
- G. Charging stand socket
- H. Plug-in transformer
- I. Appliance plug
- J. Cleaning brush
- K. Oil for blade set

* Attachment combs are optional accessories and can vary from model to model.

Charging the battery

1. Connect the appliance plug (I) on the plug-in transformer to the charging stand socket (G) (Fig. 4a).
 - The appliance can also be connected directly to the plug-in transformer for charging (Fig. 2a/b).
 - Battery overcharging is prevented thanks to intelligent charge management.
2. Connect the plug-in transformer to the mains socket (Fig. 4a).
3. Switch off the appliance using the on/off switch (Fig. 3a).
4. Place appliance on the charging stand (Fig. 4) or connect directly to the plug-in transformer (Fig. 2a/b). A signal will sound and the charging process begins.
5. Depending on the charge status, the corresponding segment of the battery power indicator will flash during the charging process. Once the battery is fully charged, all segments of the battery power indicator will remain lit continuously.
6. After the appliance has been removed from the charging stand, the display goes out after approx. 30 seconds (power saving mode).
7. It should take around 60 minutes for the appliance to charge to full capacity.
8. Once the battery is fully charged, a signal will sound

Battery Operation

1. Switch on the appliance using the on/off switch and switch off after use (Fig. 3a/b).
 - After the appliance has been switched off, the display goes out about 30 seconds later (power saving mode).
 - When the battery is fully charged, the appliance can be used for up to 90 minutes without mains connection.
 - The charge status of the battery is displayed by the battery power indicator (C). When the battery has fully run down, the appliance switches itself off automatically.
 - In case of insufficient maintenance of the blade set, the operating time can be reduced considerably.

Mains Operation

1. Connect the appliance plug (I) on the plug-in transformer to the appliance socket (F) (Fig. 2a).
2. Connect the plug-in transformer to the mains socket (Fig. 2b).
3. Switch on the appliance using the on/off switch and switch off after use (Fig. 3a/b).

OPERATION

Setting the cutting length

The cutting length can be adjusted to between 0.7mm and 3mm (5 possible positions) using the cutting-length adjustment integrated into the blade set (Fig.5).

Cutting with attachment combs

The appliance can also be operated with attachment combs.

In order to achieve the indicated cutting length, the cutting length adjustment lever should be set to position 1 (Fig. 5).

Attaching/removing the attachment comb

1. Slide the attachment comb on to the blade set in the direction of the arrow until it reaches the limit (Fig. 6a).
2. The attachment comb can be removed by pushing it in the direction of the arrow (Fig. 6a).

Maintenance, cleaning and Care.

- Remove the attachment comb (Fig. 6b) after every use and lift the blade set out of the housing (Fig. 7a).
- Use the cleaning brush to remove any cut hairs from the housing opening and from the blade set (Fig. 8).
- The cleaning lever (Fig. 8b) can also be pressed. This allows the cut hairs that accumulate between the bottom blade and the top blade to be easily removed using the cleaning brush.
- Only wipe the appliance with a soft, slightly damp cloth
- Oil the blade set with the blade set oil (Fig. 9)
- For good and long-lasting cutting performance, it is important to oil the blade set frequently.
- If the cutting performance deteriorates after long use despite regular cleaning and oiling, the blade set should be replaced.

Automatic sensor system

To give you advance notice of an urgent need for maintenance care, your hair cutting appliance has been equipped with an automatic sensor system.

- The sensor system automatically recognises when the blade set needs oiling or cleaning.
- After the appliance is switched off, an acoustic signal will sound and the battery power indicator will flash for 2 minutes.
- The acoustic signal and the flashing of the battery power indicator can be cancelled (turned off) by briefly switching the appliance on and off.
- Before using the appliance again, it is strongly recommended to clean the appliance and oil the blade set. See section Maintenance, Cleaning and care.
- Failure to observe these instructions may result in damage to and early failure of the appliance, which will void all guarantee claims.

Changing the blade set

Removing the blade set:

1. Switch the appliance off using the on/off switch (Fig. 3a) and disconnect from the power supply.
2. Slide the blade set off the housing in the direction of the arrow (Fig. 7a). Remove the blade set.

Replacing the blade set:

1. Replace the blade set by hooking it into the housing. The small lug at the base of the blade should be aligned with the indent on the clipper casing. Press the blade down until it clicks into position (Fig. 7b).

Problem elimination

Blade set is cutting badly or pulling hair out.

Cause: Blade set is dirty or worn.

- Clean and oil the blade set (Fig.8/9); if this does not resolve the problem, replace the blade set (Fig. 7).

Battery life is too short.

Cause: Blade set and housing opening are dirty.

- Clean and oil the blade set (Fig. 8/9).
A blade set that is very dirty and has not been oiled can halve the available battery life! If the blade set is clean and oiled and the battery life is still far too short, it is likely that the batteries are nearing the end of their life.
- Battery life generally decreases at a steady rate when the appliance is used on a day-to-day

basis. The batteries used here are specially designed for professional and everyday use, but are also affected by this.

Battery power indicator light does not light up.

Cause: Appliance has not been correctly placed on the charging stand

- Ensure that the hand-held appliance has been correctly placed on the charging stand.

Cause: Defective power supply.

- Ensure that the plug-in transformer is plugged into the mains socket.
- Check the mains cable for possible damage.
- Check the power supply.

Entire battery power indicator is flashing

- Check whether the blade set is blocked and the blade is able to move.
- Switch the appliance on and off. If the entire display is flashing, please contact your specialist retailer or the Wahl Customer Service team.

Battery power indicator light does not light up.

Cause: Appliance has not been correctly placed on the charging stand.

Battery Removal, Disposal and Replacement

For removal instructions see page 33

Skin injury

Cause: Too much contact pressure on the skin.

- Reduce contact pressure when cutting close to skin.

Cause: Damaged blade set.

- Check whether the blade edges or teeth are damaged and replace the blade set if necessary.
- NEVER use a damaged blade as this will cause injury.

BRAVINI RECHARGEABLE DOG TRIMMER

Model: BRAVINI - WM6590

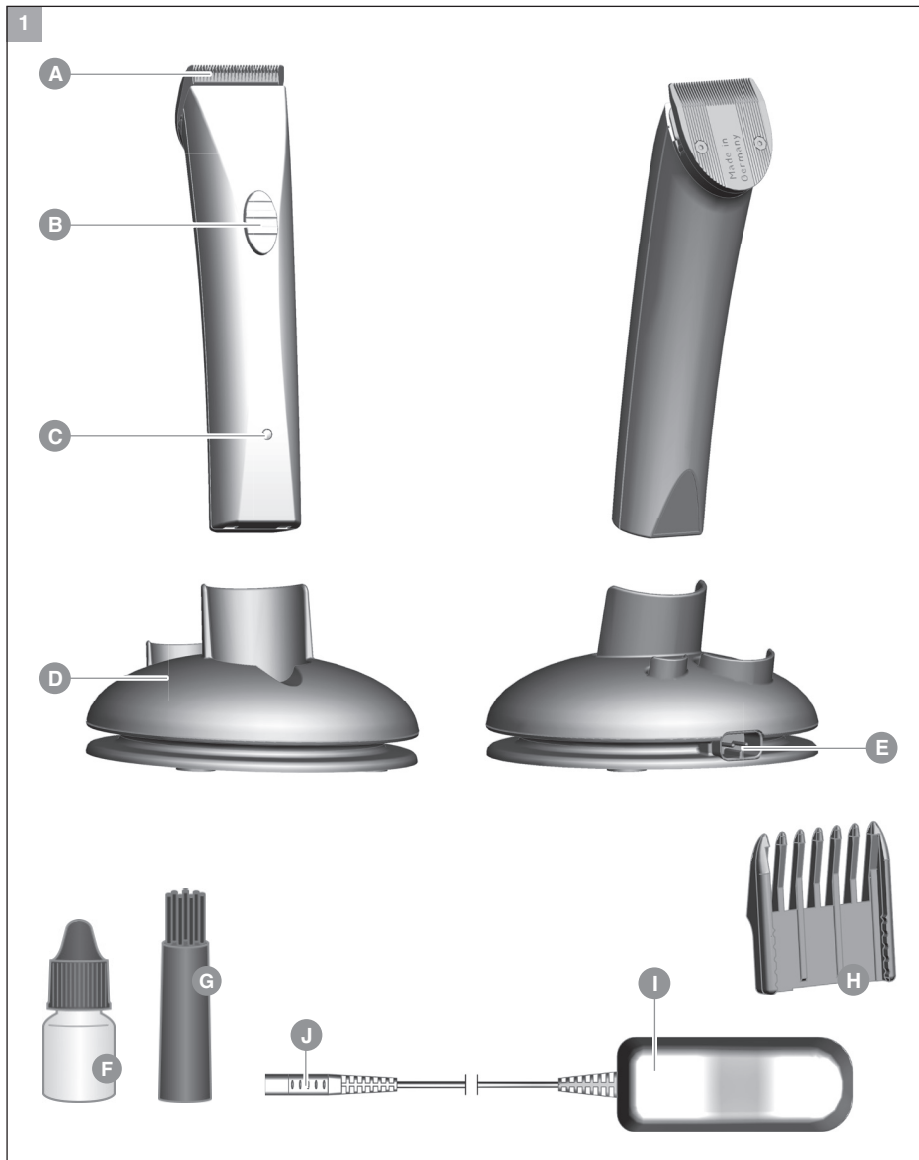



Model: **BRAVMINI RECHARGEABLE DOG TRIMMER - WM6590**

Description of parts (Fig. 1)

- A. Blade set
- B. On/off switch
- C. Charging indicator
- D. Charging stand
- E. Charging stand socket
- F. Oil for blade set
- G. Cleaning brush
- H. Attachment comb
- I. Plug-in transformer
- J. Appliance plug

* Before the appliance is used for the first time it should be charged for **16** hours.

Charging the Rechargeable Battery

1. Connect the appliance plug (J) on the plug-in transformer to the charging stand socket (E) (Fig. 2a). Battery overcharging is prevented thanks to intelligent charge management.
2. Connect the plug-in transformer to the mains socket (Fig. 2a).
3. Switch off the appliance using the on/off switch (Fig. 3a).
4. Place the appliance on the charging station (Fig. 2) · During charging, the charging indicator (C) is illuminated.
 - After the appliance has been removed from the charging stand, the display goes out.
 - It takes no more than 16 hours for the appliance to charge to full capacity.

Battery Operation

1. Switch on the appliance using the on/off switch and switch off after use (Fig. 3a/b).
 - With the battery fully charged, the appliance can be operated for up to 100 minutes. This capacity is attained after approx. 5 - 10 charging cycles. In case of insufficient maintenance of the blade set, the operating time can be reduced considerably.

OPERATION

Cutting with the attachment comb

The appliance can also be operated with an attachment comb. The attachment comb has 5 indent positions for adjusting the length of cut. The further the attachment comb is pushed in (retracted), the shorter the length of cut. The length of cut can be adjusted from 3 mm (Fig. 5a) to 6 mm (Fig. 5b).

Attachment Comb

Attaching/removing the attachment comb

1. Slide the attachment comb on to the blade set in the direction of the arrow until it reaches the limit stop (Fig. 4a).
2. The attachment comb can be removed by pushing it in the direction of the arrow (fig 4b)

If the cutting performance deteriorates after long use despite regular cleaning and oiling, the blade set should be replaced.

Changing the blade set

Removing the blade set:

1. Switch the appliance off using the on/off switch (Fig. 3a) and disconnect from the power supply.
2. Slide the blade set off the housing in the direction of the arrow (Fig. 6a). Remove the blade set.

Replacing the blade set:

1. Replace the blade set by hooking it into the housing. The small lug at the base of the blade should be aligned with the indent on the clipper casing. Press the blade down until it clicks into position (Fig. 6b).

Battery Removal, Disposal and Replacement

For removal instructions see page 33

MINI ARCO CORD /CORDLESS DOG TRIMMER

Model: MINI ARCO - WM6565

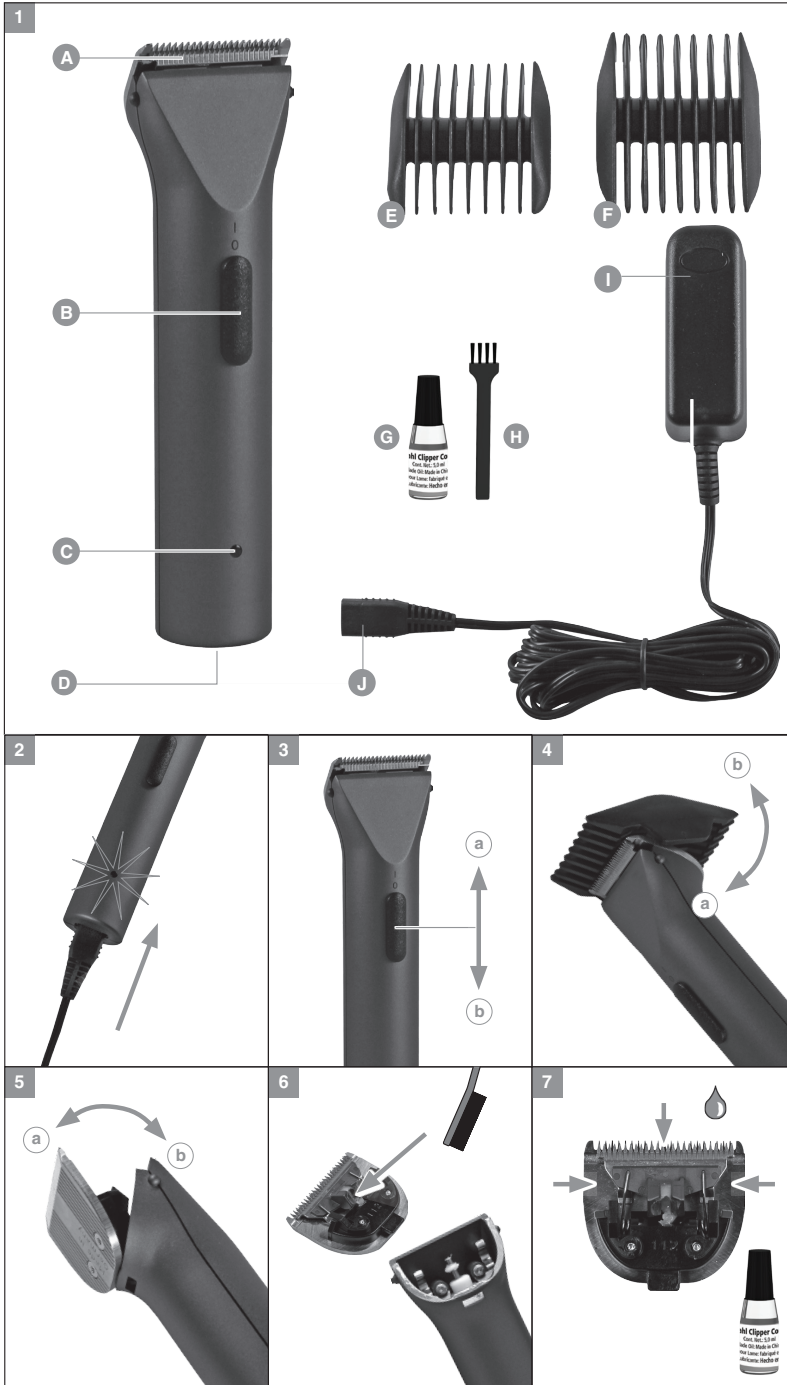

Model: **MINI ARCO CORD / CORDLESS DOG TRIMMER - WM6565**

Description of parts (Fig. 1)

- A. Blade set
- B. On/off switch
- C. Charging indicator light
- D. Appliance socket
- E. Attachment comb small = cutting lengths 3 mm and 6 mm
- F. Attachment comb large = cutting lengths 9 mm and 12 mm
- G. Cleaning brush
- H. Oil for blade set
- I. Plug-in transformer
- J. Appliance plug

Charging the battery

Before the appliance is used for the first time it should be charged for 2 hours.

1. Connect the appliance plug (J) on the plug-in transformer to the appliance socket (D) (Fig. 2).
Battery overcharging is prevented thanks to intelligent charge management.
2. Connect the plug-in transformer to the mains socket
3. Switch off the appliance using the on/off switch (Fig. 3b).
 - During charging, the charging indicator (C) flashes at evenly spaced intervals. When the battery is fully charged, the charging indicator flashes at a different rate (16 on / 1 off).
 - It should take around 2 hours for the appliance to charge to full capacity

Battery Operation

1. Switch on the appliance using the on/off switch and switch off after use (Fig. 3a/b).
 - When the battery is fully charged, the appliance can be used for up to 100 minutes without mains connection. This capacity is attained after approx. 5 - 10 charging cycles.
 - Insufficient maintenance of the blade set will reduce operating time considerably.

Mains Operation

1. Connect the appliance plug (J) on the plug-in transformer to the appliance socket (D) (Fig. 2).
2. Insert the plug-in transformer into the mains socket.
3. Switch on the appliance using the on/off switch and switch off after use (Fig. 3a/b).

OPERATION

Cutting with the attachment comb

The appliance can also be operated with attachment combs. The following attachment combs are included as standard:

- Attachment comb small = cutting lengths 3 mm and 6 mm
- Attachment comb large = cutting lengths 9 mm and 12 mm
- The cutting length (in mm) is shown on the attachment comb.
- One attachment comb can be used for two different cutting lengths. For the second cutting length, all you need to do is remove the attachment comb, rotate and replace.
- The advantage of these attachment combs is that no matter the angle at which you approach the hair, you always achieve the same cutting length.

Attaching/removing the attachment comb

1. Place the attachment comb onto the cutting edge of the blade set and press it down onto the blade set into the knobs in the direction of the housing until it clicks into position (Fig. 4a).
2. The attachment comb can be removed by pushing it in towards the cutting edge (Fig. 4b).

Changing the blade set

Removing the blade set:

1. Switch the appliance off using the on/off switch (Fig. 3b) and disconnect from the power supply.
2. Slide the blade set off the housing in the direction of the arrow (Fig. 5a). Remove the blade set.

Replacing the blade set:

1. Replace the blade set by hooking it into the housing. The small lug at the base of the blade should be aligned with the indent on the clipper casing. Press the blade down until it clicks into position (Fig. 5b).

Battery Removal, Disposal and Replacement
For removal instructions see page 33

STAINLESS STEEL BLADES AND ATTACHMENT COMBS

Competition Series Blades

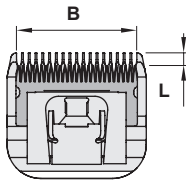
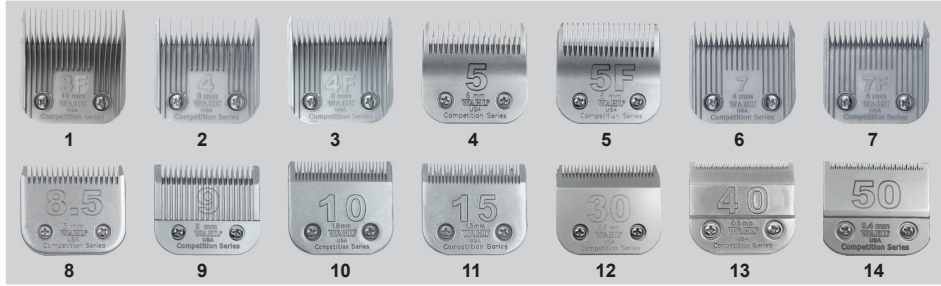

	L	B
1	10mm (#3F)	42mm
2	8mm (#4)	42mm
3	8mm (#4F)	42mm
4	6mm (#5)	42mm
5	6mm (#5F)	42mm
6	4mm (#7)	42mm
7	4mm (#7F)	42mm
8	3mm (#8.5)	42mm
9	2mm (#9)	42mm
10	1.8mm #10)	42mm
11	1.5mm (#15)	42mm
12	0.8mm (#30)	42mm
13	0.6mm (#40)	42mm
14	0.4mm (#50)	42mm

Competition Blade Comb Attachments



# NAME	LENGTH	COLOUR
#5	3mm	RED
#4	6mm	PURPLE
#2	10mm	BLUE
#1	13mm	ORANGE
#0	16mm	YELLOW
#A	19mm	LAVENDER
#C	22mm	GREEN
#E	25mm	LIGHT BLUE

Arco/Bravura Blades

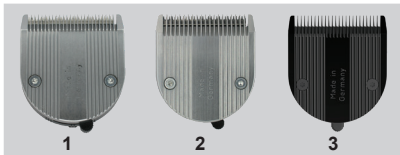

	Cutting lengths	
1	1854 Standard	0.7 - 3mm
2	1854 Course	0.7 - 3mm
3	Diamond	0.7 - 3mm

Arco/Bravura comb attachments

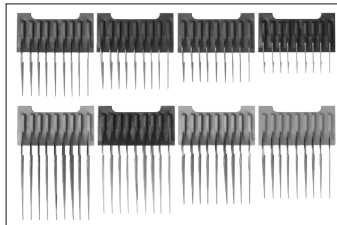
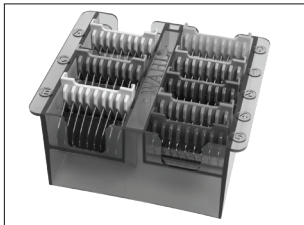

# NAME	LENGTH	COLOUR
#5	3mm	RED
#4	6mm	PURPLE
#2	10mm	BLUE
#1	13mm	ORANGE
#0	16mm	YELLOW
#A	19mm	LAVENDER
#C	22mm	GREEN
#E	25mm	LIGHT BLUE

BATTERY REPLACEMENT, REMOVAL AND DISPOSAL

MINI ARCO - WM6565 BRAVMINI - WM6590

For battery replacement the entire, intact trimmer should be sent to: Wahl (UK) Ltd Customer Services (the address can be found on the reverse of this booklet) or taken to a suitably qualified professional. The battery should only be replaced by the original manufacturers spare.

Battery Removal and Disposal

At the end of its life, when it will no longer take a full charge, the battery in your trimmer must be removed and recycled/disposed of correctly. Batteries should be disposed of at an official collection point. If you are having trouble removing the battery you can also return the product to Wahl (UK) Ltd Customer Services who will dispose of it in an environmentally safe way.

To remove the battery follow these steps:

1. Unplug the transformer from the outlet, disconnect from trimmer and allow the batteries to completely run down before disassembly.
2. Remove the Blade
3. Using a Torx 7 screwdriver, remove the 2 screws found under the blade
4. Prize the Trimmer apart along the join in the housing
5. Remove the motor and PCB assembly
6. Remove the battery by prizing up from the PCB (be careful not to puncture the battery)
7. Apply tape to both ends of the battery before recycling/disposing.

Replacement batteries can be ordered from: Wahl (UK) Ltd Customer Services (the address can be found on the reverse of this booklet). The battery should only be replaced by the original manufacturers spare.

ARCO - WM6565

Battery Removal and Disposal

At the end of its life, when it will no longer take a full charge, the battery in your clipper must be removed and recycled/disposed of correctly. Batteries should be disposed of at an official collection point. If you are having trouble removing the battery you can also return the product to Wahl (UK) Ltd Customer Services who will dispose of it in an environmentally safe way.

To remove the battery follow these steps:

1. Allow the batteries to completely run down before removing.
2. Press the clips on each side of the battery and remove.
3. Apply tape to over the contacts of the battery before recycling/disposing.

Bravura - WM6870-803

Lithium Battery Replacement, Removal and Disposal

For battery replacement the entire, intact clipper or trimmer should be sent to: Wahl (UK) Ltd Customer Services (the address can be found on the reverse of this booklet) or taken to a suitably qualified professional. The battery should only be replaced by the original manufacturers spare, for safety reasons a substitute should not be used.

Do not attempt to remove the battery. Lithium-Ion batteries can explode, catch fire, and/or cause burns if disassembled, damaged or exposed to water or high temperatures.

Lithium Battery Disposal

Do not dispose of this product or the Lithium battery in the normal household waste.

The product should be returned to Wahl Customer Services where we offer a take back service or taken to a local collection facility where they will be dealt with safely and sent for the appropriate recycling.

WIRING AND DISPOSAL

WIRING - Max 45 - KM6245 / WM6245

WARNING: If the supply cord is damaged it must be replaced by the manufacturers service agent or a similarly qualified person in order to avoid a hazard.

The wires in the mains lead are coloured in accordance to the following code:

Blue Neutral (N) Brown live (L)

This appliance is fitted with a 3 pin plug which has a 3 amp fuse fitted.

If the plug supplied is not suitable for your socket or becomes damaged, it should be cut off and disposed of, and a suitable plug fitted as detailed below.

As the colours of the wires in the mains lead of this appliance may not correspond with the colour markings identifying the terminals in your plug, proceed as follows.

The wire which is coloured BLUE must be connected to the terminal in the plug which is marked with the letter 'N' or coloured BLACK or BLUE.

The wire which is coloured BROWN must be connected to the terminal in the plug which is marked with the letter 'L' or coloured RED or BROWN.

DO NOT connect either wire to the terminal in the plug which is marked with the letter 'E' or has the Earth symbol, or coloured GREEN or GREEN/YELLOW.

If a 13 amp (BS 1363) plug is used, a 3 amp fuse must be fitted. If any other type of plug is used a 5 amp fuse must be fitted either in the plug or adaptor at the distribution board. Replacement fuses should be approved to BS 1362

Fuse cover must be refitted when changing the fuse. If the fuse cover is lost the plug must not be used until a replacement is obtained. Information for obtaining the correct fuse is marked on the carrier itself and in the bottom of the fuse cavity in the plug. These may be obtained from Wahl (UK) Ltd.

KM5 - WM6260
KM10 - WM6261
Power Grip - 8879

WARNING: If the transformer is damaged it must be replaced by the manufacturers service agent or a similarly qualified person in order to avoid a hazard. This product must only be used with transformer supplied. Should a replacement be required contact Wahl (UK) Ltd customer services.

WIRING - Arco - WM6854
Bravura - WM6870
BravMini - WM6590
Mini Arco - WM6565

WARNING: If the transformer is damaged it must be replaced. This product must only be used with the transformer supplied. Should a replacement be required contact Wahl (UK) Ltd customer services.

DISPOSAL

Handle with care! Environmental damage in the case of incorrect disposal.

Correct disposal will ensure environmental protection and prevent any potentially harmful impacts on people and the environment.

Adhere to the relevant legal requirements when disposing of the appliance.

Information on the disposal of electrical and electronic appliances in the European Community:

Within the European Community, national regulations are specified for the disposal of electrical appliances, based on **EU Waste Electrical and Electronic Equipment Directive 2002/96/EC (WEEE)**.

In accordance with this, the appliance can no longer be disposed of with the local or domestic waste.

The appliance will be accepted free of charge by local collection points or recycling centres.

The packaging for this product is made from recyclable materials. Dispose of this in an environmentally friendly manner by recycling it. Information on the disposal of electrical and electronic appliances in the European Community:



WEEE

WASTE ELECTRICAL & ELECTRONIC EQUIPMENT DIRECTIVE 2002/96/EC (WEEE)

At the end of this products life it should not be disposed of with general household waste.

Care should be taken to dispose of in a suitable manner in accordance with your Local Authority regulation

GUARANTEE

This product is guaranteed against defects in material and workmanship for a period of 2 years from the date of original purchase or receipt as a gift.

The guarantee becomes invalid in the case of misuse or repair by unauthorised persons.

Should this product become defective during the warranty period, return it to the store of purchase together with your proof of purchase for repair or replacement without any charges to you.

This guarantee in no way affects your rights under statutory law in the United Kingdom.

GENERAL CLEANING

Aggressive chemicals could damage the appliance and accessories

- Never use solvents or scouring agents.
- Only use cleaning agents and blade set oil recommended by the manufacturer.
- Hygienic spray and blade set oil are available from your dealer or our Customer Service Team.

Never immerse the appliance in water.

Remove the attachment comb after each use and clean the blade set using the cleaning brush.

Remove the blade set and clean the blade. Remove any hairs and dirt between top and bottom blade with the cleaning brush.

The appliance must be kept clean. Use only a slightly damp cloth for cleaning the housing and charging stand if applicable. Never use solvents or scouring agents.

Oil the blade set regularly using the oil supplied to maintain the cutting performance and ensure a long service life. Replace the attachment comb to protect the blade when not in use.

The blade set should be replaced if cutting performance is reduced after extended use.



P R O F E S S I O N A L

WAHL (UK) LTD

Sterling House
Clipper Close
Ramsgate
Kent
CT12 5GG

Customer Services

T: 01227 740066

W: www.wahl.co.uk

E: customer.services@wahl.co.uk